

Upholstery

Ascent



Ascent | Marigold

With each pass of dye, our Ascent leather takes you on a topographic path through the mountains. Inspired by the hills of Topanga State Park it weaves and meanders through your space like flowing water.

Hand dyed graphics create a modern juxtaposition between material and pattern. Upholstery is a way to transform your space through objects. Reinvent your favorite chair or create statement pieces for each room from scratch. All of our leather upholstery is hand dyed to order by our team of artisans and suitable for residential and commercial spaces.

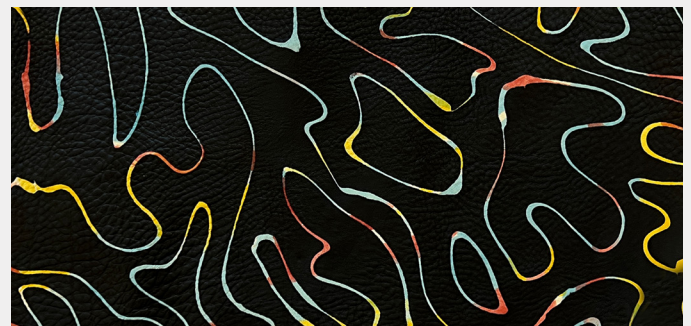

Ascent | Helix

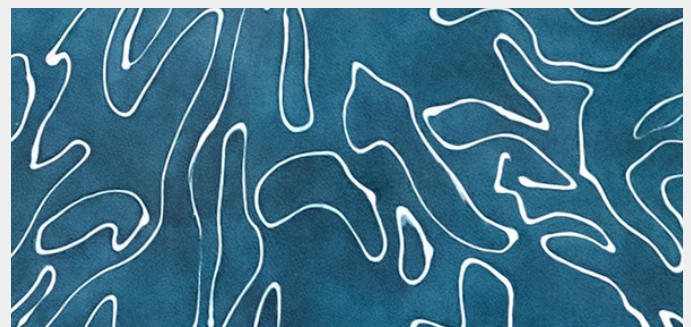

Ascent | Indigo

Upholstery

Ascent



Pattern	Ascent.
Material	Hand dyed cowhide leather.
Leather Type	Natural milled texture and full grain cowhide.
Repeat	Pattern seamlessly over full cowhide.
Finish	Satin-sheen, water and stain resistant protective coating.
Weight	3 - 4 oz.
Types of Use	Indoor wrapped upholstery, surface inlay, and headboards. Residential and commercial interiors.
Pricing	Sold by the square foot.
Available Sizes	Custom sizes available. Please check with your upholsterer.
Sample Size*	5" x 7" (13 x 18 cm) *Purchase on product pages: www.avoavo.com .
Minimum Order	Whole hide: 45 - 55 sq ft (4.2 - 5.1 sq m) average.
Ordering	Contact us directly to purchase. All inquiries can be made to inquire@avoavo.com . Orders require a 50% deposit.
Trade Account	We offer a trade discount to interior designers and architects. Please contact us for a quote.
Lead Time	Made to order 6 - 8 weeks lead time.
Care	Dust with a dry cloth, sweep, or gently vacuum with a hose attachment (never use "carpet mode" or attachments with a spinning brush). If a spill or spot should occur, blot immediately with a clean absorbent cloth or sponge - no wiping or scrubbing. Then let air dry completely. Do not use solvents or harsh cleaners. Recondition as needed. Always perform a test before proceeding.
Customization	Size, scale and color can be customized. See our color library for reference: www.avoavo.com/color .
Variations	Leather is a natural product that we dye by hand. Each hide is unique and lots made at different times may vary slightly in color. Avoid exposure to direct sunlight as it might change or fade the color of your leather.
Manufacture	Hand dyed in Brooklyn. Made in the United States.

Upholstery

Leather Upholstery Guide

Here is a general reference guide to upholstery . Please check with your upholsterer



1.5 yds. / 27 sq. ft.

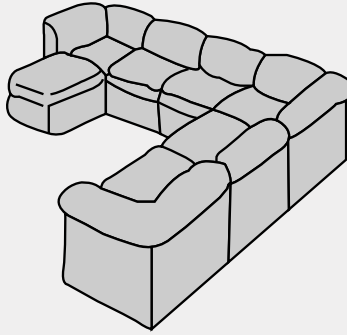

30.5 yds. / 711 sq. ft.

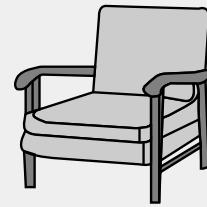

3.5 yds. / 83 sq. ft.

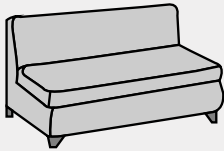

9 yds. / 152 sq. ft.

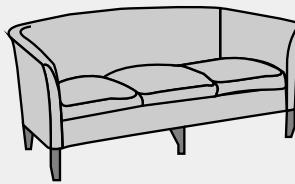

12 yds. / 216 sq. ft.

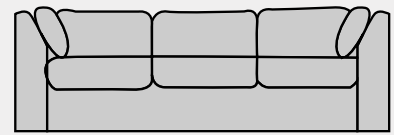

22 yds. / 396 sq. ft.



1 yd. / 18 sq. ft.

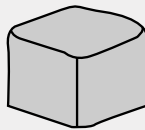

1.5 yds. / 27 sq. ft.

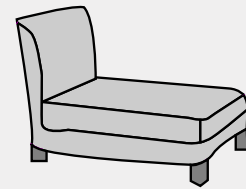

5.5 yd. / 90 sq. ft.

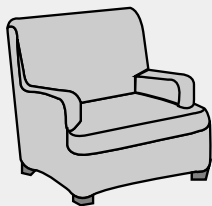

5.5 yds. / 90 sq. ft.

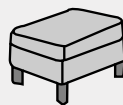

2.5 yds. / 45 sq. ft.

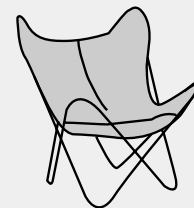

5.5 yd. / 90 sq. ft.

Upholstery

Cane



Cane | Sage

Cane layers together translucent lines into a structured nest. This design is a perfectly imperfect geometric rug, inspired by traditional cane chairs.

Hand dyed graphics create a modern juxtaposition between material and pattern. Upholstery is a way to transform your space through objects. Reinvent your favorite chair or create statement pieces for each room from scratch. All of our leather upholstery is hand dyed to order by our team of artisans and suitable for residential and commercial spaces.

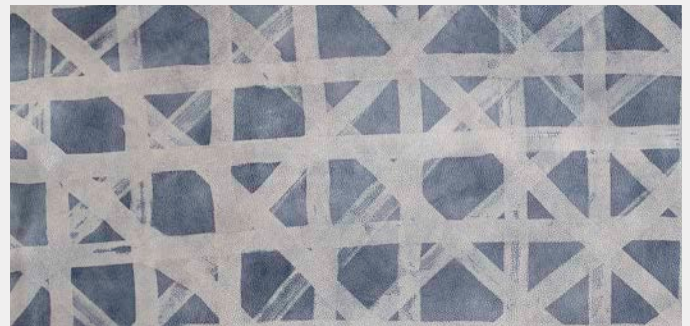

Cane | Slate

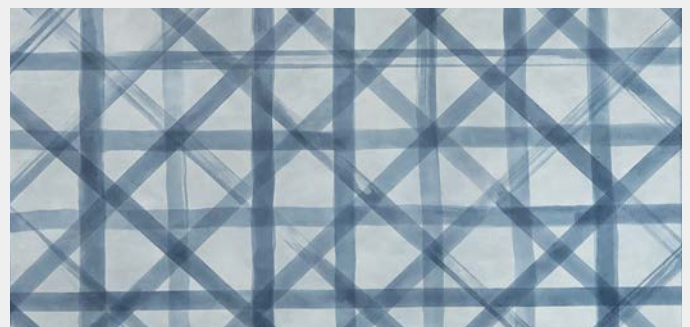

Cane | Denim

Upholstery Cane



Pattern	Cane.
Material	Hand dyed cowhide leather.
Leather Type	Natural milled texture and full grain cowhide.
Repeat	Pattern seamlessly over full cowhide.
Finish	Satin-sheen, water and stain resistant protective coating.
Weight	3 - 4 oz.
Types of Use	Indoor wrapped upholstery, surface inlay, and headboards. Residential and commercial interiors.
Pricing	Sold by the square foot.
Available Sizes	Custom sizes available. Please check with your upholsterer.
Sample Size*	5" x 7" (13 x 18 cm) *Purchase on product pages: www.avoavo.com .
Minimum Order	Whole hide: 45 - 55 sq ft (4.2 - 5.1 sq m) average.
Ordering	Contact us directly to purchase. All inquiries can be made to inquire@avoavo.com . Orders require a 50% deposit.
Trade Account	We offer a trade discount to interior designers and architects. Please contact us for a quote.
Lead Time	Made to order 6 - 8 weeks lead time.
Care	Dust with a dry cloth, sweep, or gently vacuum with a hose attachment (never use "carpet mode" or attachments with a spinning brush). If a spill or spot should occur, blot immediately with a clean absorbent cloth or sponge - no wiping or scrubbing. Then let air dry completely. Do not use solvents or harsh cleaners. Recondition as needed. Always perform a test before proceeding.
Customization	Size, scale and color can be customized. See our color library for reference: www.avoavo.com/color .
Variations	Leather is a natural product that we dye by hand. Each hide is unique and lots made at different times may vary slightly in color. Avoid exposure to direct sunlight as it might change or fade the color of your leather.
Manufacture	Hand dyed in Brooklyn. Made in the United States.

Upholstery

Leather Upholstery Guide

Here is a general reference guide to upholstery . Please check with your upholsterer



1.5 yds. / 27 sq. ft.

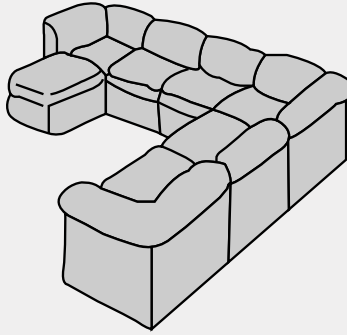

30.5 yds. / 711 sq. ft.

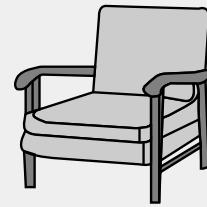

3.5 yds. / 83 sq. ft.

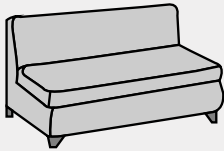

9 yds. / 152 sq. ft.

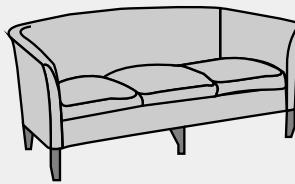

12 yds. / 216 sq. ft.

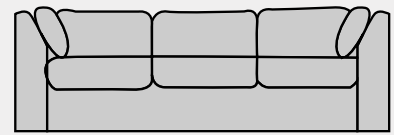

22 yds. / 396 sq. ft.



1 yd. / 18 sq. ft.

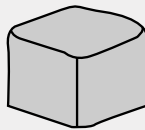

1.5 yds. / 27 sq. ft.

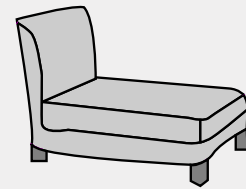

5.5 yd. / 90 sq. ft.

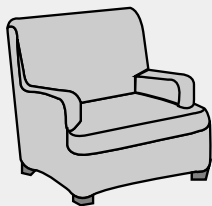

5.5 yds. / 90 sq. ft.

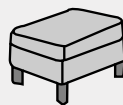

2.5 yds. / 45 sq. ft.

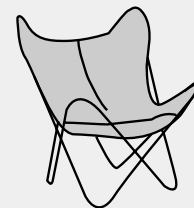

5.5 yd. / 90 sq. ft.

Upholstery

Linen



Linen | Antique Jade

Linen is classic and fun. An all over upholstery pattern with a strong visual texture. Dial it up with coordinating color combos, or keep it neutral and subtle.

Hand dyed graphics create a modern juxtaposition between material and pattern. Upholstery is a way to transform your space through objects. Reinvent your favorite chair or create statement pieces for each room from scratch. All of our leather upholstery is hand dyed to order by our team of artisans and suitable for residential and commercial spaces.

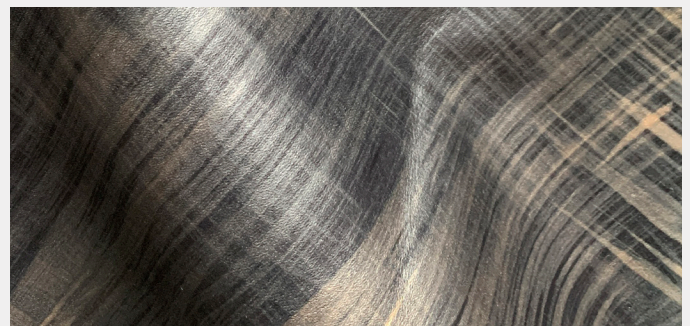

Linen | Black and Bronze



Linen | Antique Turquoise

Upholstery

Linen



Pattern	Linen.
Material	Hand dyed cowhide leather.
Leather Type	Smooth texture and full grain hide.
Repeat	Pattern seamlessly over full cowhide.
Finish	Satin-sheen, water and stain resistant protective coating.
Weight	2 - 3 oz.
Types of Use	Indoor wrapped upholstery, surface inlay, and headboards. Residential and commercial interiors.
Pricing	Sold by the square foot.
Available Sizes	Custom sizes available. Please check with your upholsterer.
Sample Size*	5" x 7" (13 x 18 cm) *Purchase on product pages: www.avoavo.com .
Minimum Order	Whole hide: 45 - 55 sq ft (4.2 - 5.1 sq m) average.
Ordering	Contact us directly to purchase. All inquiries can be made to inquire@avoavo.com . Orders require a 50% deposit.
Trade Account	We offer a trade discount to interior designers and architects. Please contact us for a quote.
Lead Time	Made to order 6 - 8 weeks lead time.
Care	Dust with a dry cloth, sweep, or gently vacuum with a hose attachment (never use "carpet mode" or attachments with a spinning brush). If a spill or spot should occur, blot immediately with a clean absorbent cloth or sponge - no wiping or scrubbing. Then let air dry completely. Do not use solvents or harsh cleaners. Recondition as needed. Always perform a test before proceeding.
Customization	Size, scale and color can be customized. See our color library for reference: www.avoavo.com/color .
Variations	Leather is a natural product that we dye by hand. Each hide is unique and lots made at different times may vary slightly in color. Avoid exposure to direct sunlight as it might change or fade the color of your leather.
Manufacture	Hand dyed in Brooklyn. Made in the United States.

Upholstery

Leather Upholstery Guide

Here is a general reference guide to upholstery . Please check with your upholsterer



1.5 yds. / 27 sq. ft.

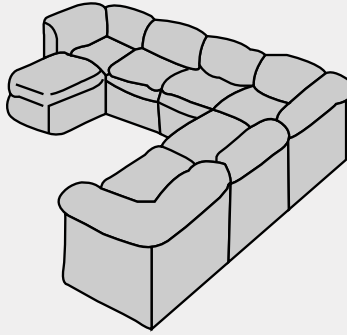

30.5 yds. / 711 sq. ft.

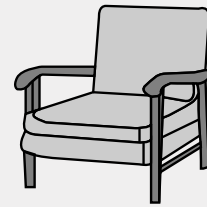

3.5 yds. / 83 sq. ft.

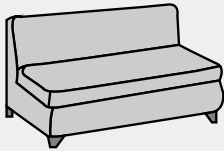

9 yds. / 152 sq. ft.

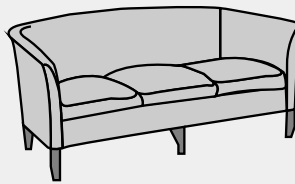

12 yds. / 216 sq. ft.

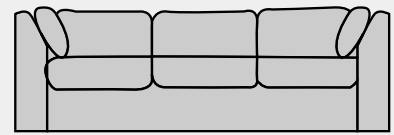

22 yds. / 396 sq. ft.



1 yd. / 18 sq. ft.

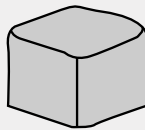

1.5 yds. / 27 sq. ft.

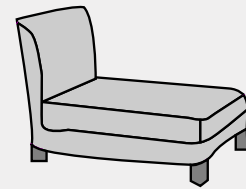

5.5 yd. / 90 sq. ft.

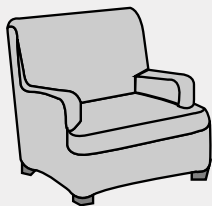

5.5 yds. / 90 sq. ft.

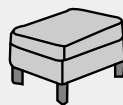

2.5 yds. / 45 sq. ft.

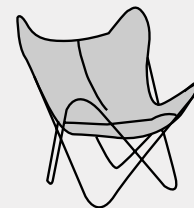

5.5 yd. / 90 sq. ft.

Upholstery

Marble Glaze

AVO



Marble Glaze | Frosted Black

Marble Glaze is an all over texture that uses a metallic dye in a traditional Italian stucco technique on full grain leather.

Hand dyed graphics create a modern juxtaposition between material and pattern. Upholstery is a way to transform your space through objects. Reinvent your favorite chair or create statement pieces for each room from scratch. All of our leather upholstery is hand dyed to order by our team of artisans and suitable for residential and commercial spaces.



Marble Glaze | Frosted Honey



Marble Glaze | Frosted Silver

Upholstery

Marble Glaze



Pattern	Marble Glaze.
Material	Hand dyed cowhide leather.
Leather Type	Smooth texture and full grain hide.
Repeat	Pattern seamlessly over full cowhide.
Finish	Satin-sheen, water and stain resistant protective coating.
Weight	2 - 3 oz.
Types of Use	Indoor wrapped upholstery, surface inlay, and headboards. Residential and commercial interiors.
Pricing	Sold by the square foot.
Available Sizes	Custom sizes available. Please check with your upholsterer.
Sample Size*	5" x 7" (13 x 18 cm) *Purchase on product pages: www.avoavo.com .
Minimum Order	Whole hide: 45 - 55 sq ft (4.2 - 5.1 sq m) average.
Ordering	Contact us directly to purchase. All inquiries can be made to inquire@avoavo.com . Orders require a 50% deposit.
Trade Account	We offer a trade discount to interior designers and architects. Please contact us for a quote.
Lead Time	Made to order 6 - 8 weeks lead time.
Care	Dust with a dry cloth, sweep, or gently vacuum with a hose attachment (never use "carpet mode" or attachments with a spinning brush). If a spill or spot should occur, blot immediately with a clean absorbent cloth or sponge - no wiping or scrubbing. Then let air dry completely. Do not use solvents or harsh cleaners. Recondition as needed. Always perform a test before proceeding.
Customization	Size, scale and color can be customized. See our color library for reference: www.avoavo.com/color .
Variations	Leather is a natural product that we dye by hand. Each hide is unique and lots made at different times may vary slightly in color. Avoid exposure to direct sunlight as it might change or fade the color of your leather.
Manufacture	Hand dyed in Brooklyn. Made in the United States.

Upholstery

Leather Upholstery Guide

Here is a general reference guide to upholstery . Please check with your upholsterer



1.5 yds. / 27 sq. ft.

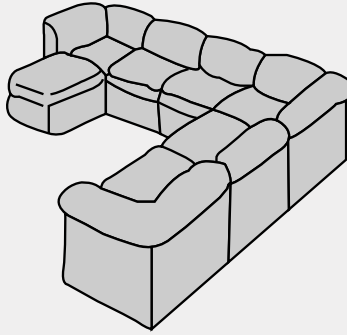

30.5 yds. / 711 sq. ft.

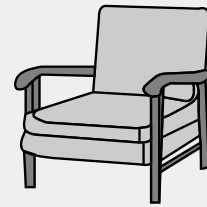

3.5 yds. / 83 sq. ft.

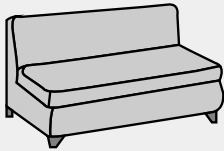

9 yds. / 152 sq. ft.

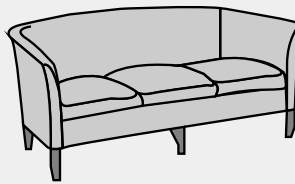

12 yds. / 216 sq. ft.

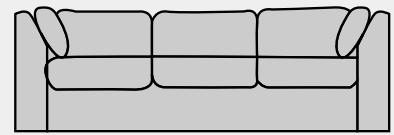

22 yds. / 396 sq. ft.



1 yd. / 18 sq. ft.

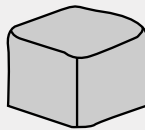

1.5 yds. / 27 sq. ft.

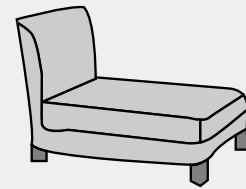

5.5 yd. / 90 sq. ft.

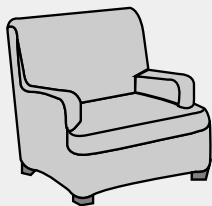

5.5 yds. / 90 sq. ft.

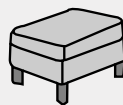

2.5 yds. / 45 sq. ft.

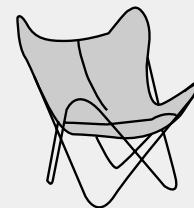

5.5 yd. / 90 sq. ft.

Upholstery

Moonflower

AVO



Moonflower | Aloe

Moonflower is a species of night-blooming morning glory. Imagine yourself standing in a field of flowers in the moonlight, as your eyes adjust seeing only an abstraction of shapes.

Hand dyed graphics create a modern juxtaposition between material and pattern. Upholstery is a way to transform your space through objects. Reinvent your favorite chair or create statement pieces for each room from scratch. All of our leather upholstery is hand dyed to order by our team of artisans and suitable for residential and commercial spaces.

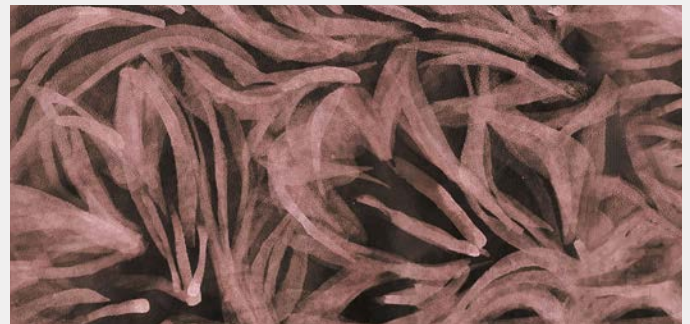

Moonflower | Rust



Moonflower | Indigo

Upholstery

Moonflower



Pattern	Moonflower.
Material	Hand dyed cowhide leather.
Leather Type	Natural milled texture and full grain cowhide.
Repeat	Pattern seamlessly over full cowhide.
Finish	Satin-sheen, water and stain resistant protective coating.
Weight	3 - 4 oz.
Types of Use	Indoor wrapped upholstery, surface inlay, and headboards. Residential and commercial interiors.
Pricing	Sold by the square foot.
Available Sizes	Custom sizes available. Please check with your upholsterer.
Sample Size*	5" x 7" (13 x 18 cm) *Purchase on product pages: www.avoavo.com .
Minimum Order	Whole hide: 45 - 55 sq ft (4.2 - 5.1 sq m) average.
Ordering	Contact us directly to purchase. All inquiries can be made to inquire@avoavo.com . Orders require a 50% deposit.
Trade Account	We offer a trade discount to interior designers and architects. Please contact us for a quote.
Lead Time	Made to order 6 - 8 weeks lead time.
Care	Dust with a dry cloth, sweep, or gently vacuum with a hose attachment (never use "carpet mode" or attachments with a spinning brush). If a spill or spot should occur, blot immediately with a clean absorbent cloth or sponge - no wiping or scrubbing. Then let air dry completely. Do not use solvents or harsh cleaners. Recondition as needed. Always perform a test before proceeding.
Customization	Size, scale and color can be customized. See our color library for reference: www.avoavo.com/color .
Variations	Leather is a natural product that we dye by hand. Each hide is unique and lots made at different times may vary slightly in color. Avoid exposure to direct sunlight as it might change or fade the color of your leather.
Manufacture	Hand dyed in Brooklyn. Made in the United States.

Upholstery

Leather Upholstery Guide

Here is a general reference guide to upholstery . Please check with your upholsterer



1.5 yds. / 27 sq. ft.

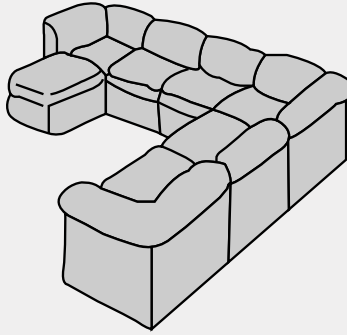

30.5 yds. / 711 sq. ft.

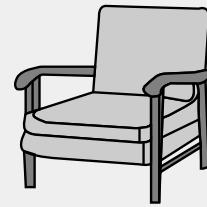

3.5 yds. / 83 sq. ft.

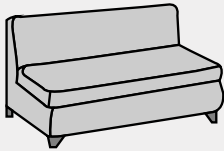

9 yds. / 152 sq. ft.

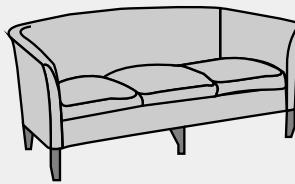

12 yds. / 216 sq. ft.

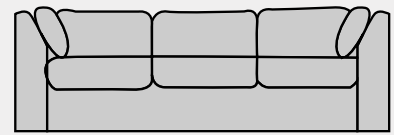

22 yds. / 396 sq. ft.



1 yd. / 18 sq. ft.

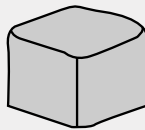

1.5 yds. / 27 sq. ft.

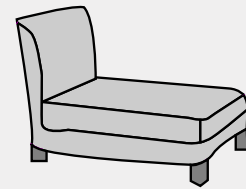

5.5 yd. / 90 sq. ft.

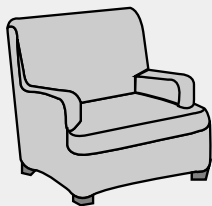

5.5 yds. / 90 sq. ft.

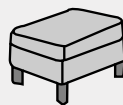

2.5 yds. / 45 sq. ft.

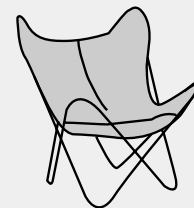

5.5 yd. / 90 sq. ft.

Upholstery

Plaid



Plaid | Ochre

Suspended layers of dye create our take on a traditional plaid. Each line is hand drawn on full grain leather.

Hand dyed graphics create a modern juxtaposition between material and pattern. Upholstery is a way to transform your space through objects. Reinvent your favorite chair or create statement pieces for each room from scratch. All of our leather upholstery is hand dyed to order by our team of artisans and suitable for residential and commercial spaces.



Plaid | Ochre



Plaid | Indigo

Upholstery Plaid



Pattern	Plaid.
Material	Hand dyed cowhide leather.
Leather Type	Natural milled texture and full grain cowhide.
Repeat	Pattern seamlessly over full cowhide.
Finish	Satin-sheen, water and stain resistant protective coating.
Weight	3 - 4 oz.
Types of Use	Indoor wrapped upholstery, surface inlay, and headboards. Residential and commercial interiors.
Pricing	Sold by the square foot.
Available Sizes	Custom sizes available. Please check with your upholsterer.
Sample Size*	5" x 7" (13 x 18 cm) *Purchase on product pages: www.avoavo.com .
Minimum Order	Whole hide: 45 - 55 sq ft (4.2 - 5.1 sq m) average.
Ordering	Contact us directly to purchase. All inquiries can be made to inquire@avoavo.com . Orders require a 50% deposit.
Trade Account	We offer a trade discount to interior designers and architects. Please contact us for a quote.
Lead Time	Made to order 6 - 8 weeks lead time.
Care	Dust with a dry cloth, sweep, or gently vacuum with a hose attachment (never use "carpet mode" or attachments with a spinning brush). If a spill or spot should occur, blot immediately with a clean absorbent cloth or sponge - no wiping or scrubbing. Then let air dry completely. Do not use solvents or harsh cleaners. Recondition as needed. Always perform a test before proceeding.
Customization	Size, scale and color can be customized. See our color library for reference: www.avoavo.com/color .
Variations	Leather is a natural product that we dye by hand. Each hide is unique and lots made at different times may vary slightly in color. Avoid exposure to direct sunlight as it might change or fade the color of your leather.
Manufacture	Hand dyed in Brooklyn. Made in the United States.

Upholstery

Leather Upholstery Guide

Here is a general reference guide to upholstery . Please check with your upholsterer



1.5 yds. / 27 sq. ft.

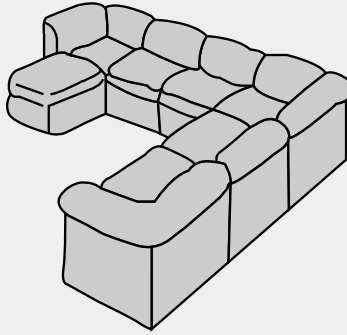

30.5 yds. / 711 sq. ft.

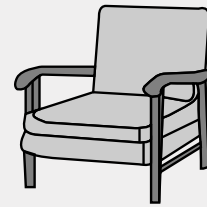

3.5 yds. / 83 sq. ft.

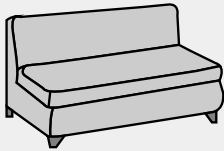

9 yds. / 152 sq. ft.

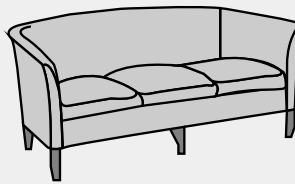

12 yds. / 216 sq. ft.

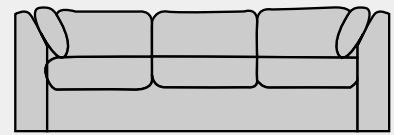

22 yds. / 396 sq. ft.



1 yd. / 18 sq. ft.

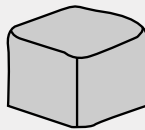

1.5 yds. / 27 sq. ft.

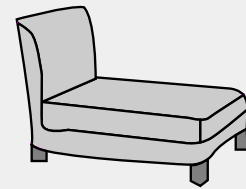

5.5 yd. / 90 sq. ft.

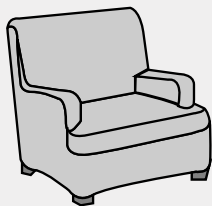

5.5 yds. / 90 sq. ft.

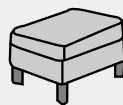

2.5 yds. / 45 sq. ft.

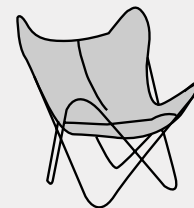

5.5 yd. / 90 sq. ft.

Upholstery Pulsar

AVO



Pulsar Linear | Agave

Pulsar is made by hand with precise intervals between brush strokes. The divide between cracks through the pattern with pulsating high energy rays.

Hand dyed graphics create a modern juxtaposition between material and pattern. Upholstery is a way to transform your space through objects. Reinvent your favorite chair or create statement pieces for each room from scratch. All of our leather upholstery is hand dyed to order by our team of artisans and suitable for residential and commercial spaces.



Pulsar Arch | Agave

Upholstery

Pulsar



Pattern	Pulsar.
Material	Hand dyed cowhide leather.
Leather Type	Natural milled texture and full grain cowhide.
Repeat	Pattern seamlessly over full cowhide.
Finish	Satin-sheen, water and stain resistant protective coating.
Weight	3 - 4 oz
Types of Use	Indoor wrapped upholstery, surface inlay, and headboards. Residential and commercial interiors.
Pricing	Sold by the square foot.
Available Sizes	Custom sizes available. Please check with your upholsterer.
Sample Size*	5" x 7" (13 x 18 cm) *Purchase on product pages: www.avoavo.com .
Minimum Order	Whole hide: 45 - 55 sq ft (4.2 - 5.1 sq m) average.
Ordering	Contact us directly to purchase. All inquiries can be made to inquire@avoavo.com . Orders require a 50% deposit.
Trade Account	We offer a trade discount to interior designers and architects. Please contact us for a quote.
Lead Time	Made to order 6 - 8 weeks lead time.
Care	Dust with a dry cloth, sweep, or gently vacuum with a hose attachment (never use "carpet mode" or attachments with a spinning brush). If a spill or spot should occur, blot immediately with a clean absorbent cloth or sponge - no wiping or scrubbing. Then let air dry completely. Do not use solvents or harsh cleaners. Recondition as needed. Always perform a test before proceeding.
Customization	Size, scale and color can be customized. See our color library for reference: www.avoavo.com/color .
Variations	Leather is a natural product that we dye by hand. Each hide is unique and lots made at different times may vary slightly in color. Avoid exposure to direct sunlight as it might change or fade the color of your leather.
Manufacture	Hand dyed in Brooklyn. Made in the United States.

Upholstery

Leather Upholstery Guide

Here is a general reference guide to upholstery . Please check with your upholsterer



1.5 yds. / 27 sq. ft.

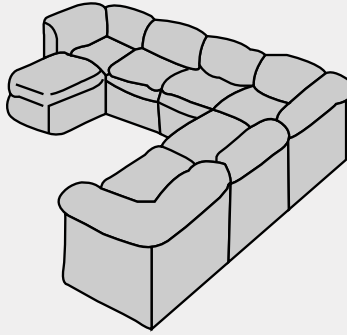

30.5 yds. / 711 sq. ft.

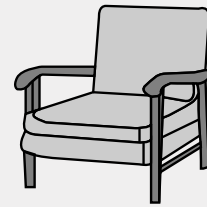

3.5 yds. / 83 sq. ft.

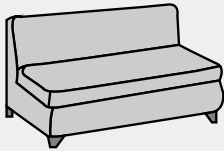

9 yds. / 152 sq. ft.

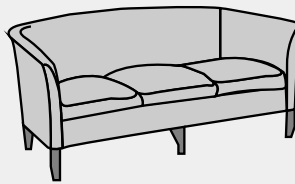

12 yds. / 216 sq. ft.

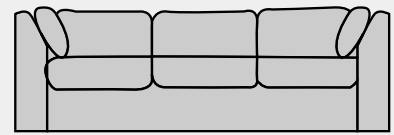

22 yds. / 396 sq. ft.



1 yd. / 18 sq. ft.

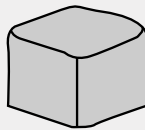

1.5 yds. / 27 sq. ft.

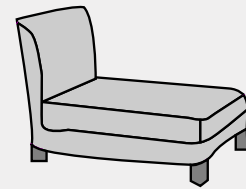

5.5 yd. / 90 sq. ft.

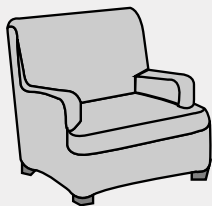

5.5 yds. / 90 sq. ft.

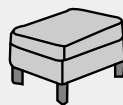

2.5 yds. / 45 sq. ft.

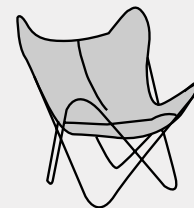

5.5 yd. / 90 sq. ft.

Upholstery

Shadow



Shadow | Marigold

This pattern captures that moment when the sun hits just right, cascading the shadows of the trees outside your window across your wall.

Hand dyed graphics create a modern juxtaposition between material and pattern. Upholstery is a way to transform your space through objects. Reinvent your favorite chair or create statement pieces for each room from scratch. All of our leather upholstery is hand dyed to order by our team of artisans and suitable for residential and commercial spaces.



Shadow | Putty



Shadow | Mineral Blue

Upholstery

Shadow



Pattern	Shadow.
Material	Hand dyed cowhide leather.
Leather Type	Natural milled texture and full grain cowhide.
Repeat	Pattern seamlessly over full cowhide.
Finish	Satin-sheen, water and stain resistant protective coating.
Weight	3 - 4 oz.
Types of Use	Indoor wrapped upholstery, surface inlay, and headboards. Residential and commercial interiors.
Pricing	Sold by the square foot.
Available Sizes	Custom sizes available. Please check with your upholsterer.
Sample Size*	5" x 7" (13 x 18 cm) *Purchase on product pages: www.avoavo.com .
Minimum Order	Whole hide: 45 - 55 sq ft (4.2 - 5.1 sq m) average.
Ordering	Contact us directly to purchase. All inquiries can be made to inquire@avoavo.com . Orders require a 50% deposit.
Trade Account	We offer a trade discount to interior designers and architects. Please contact us for a quote.
Lead Time	Made to order 6 - 8 weeks lead time.
Care	Dust with a dry cloth, sweep, or gently vacuum with a hose attachment (never use "carpet mode" or attachments with a spinning brush). If a spill or spot should occur, blot immediately with a clean absorbent cloth or sponge - no wiping or scrubbing. Then let air dry completely. Do not use solvents or harsh cleaners. Recondition as needed. Always perform a test before proceeding.
Customization	Size, scale and color can be customized. See our color library for reference: www.avoavo.com/color .
Variations	Leather is a natural product that we dye by hand. Each hide is unique and lots made at different times may vary slightly in color. Avoid exposure to direct sunlight as it might change or fade the color of your leather.
Manufacture	Hand dyed in Brooklyn. Made in the United States.

Upholstery

Leather Upholstery Guide

Here is a general reference guide to upholstery . Please check with your upholsterer



1.5 yds. / 27 sq. ft.

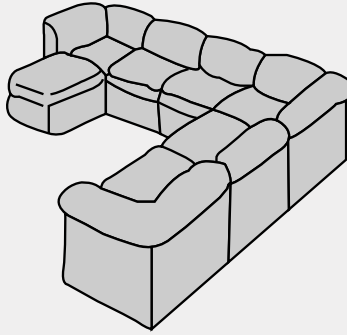

30.5 yds. / 711 sq. ft.

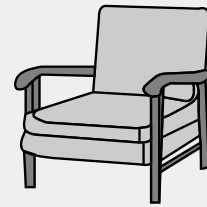

3.5 yds. / 83 sq. ft.

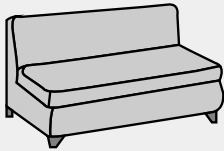

9 yds. / 152 sq. ft.

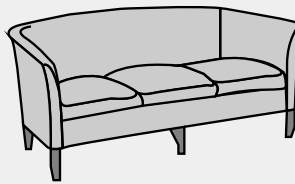

12 yds. / 216 sq. ft.

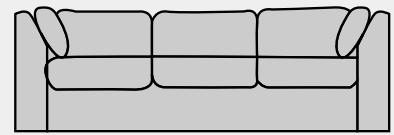

22 yds. / 396 sq. ft.



1 yd. / 18 sq. ft.

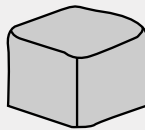

1.5 yds. / 27 sq. ft.

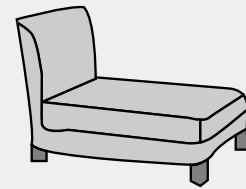

5.5 yd. / 90 sq. ft.

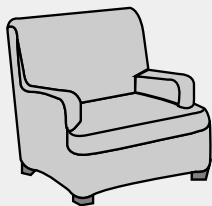

5.5 yds. / 90 sq. ft.

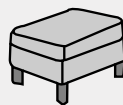

2.5 yds. / 45 sq. ft.

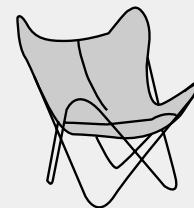

5.5 yd. / 90 sq. ft.

Upholstery

Strata



Strata | Cobalt

Light washes of glaze, layer to create visual depth on a smooth surface. Colors seamlessly blend together to create an earthen landscape.

Hand dyed graphics create a modern juxtaposition between material and pattern. Upholstery is a way to transform your space through objects. Reinvent your favorite chair or create statement pieces for each room from scratch. All of our leather upholstery is hand dyed to order by our team of artisans and suitable for residential and commercial spaces.



Strata | Vintage Coral



Strata | Sky

Upholstery

Strata



Pattern	Strata.
Material	Hand dyed cowhide leather.
Leather Type	Smooth milled texture and full grain cowhide.
Repeat	Pattern seamlessly over full cowhide.
Finish	Satin-sheen, water and stain resistant protective coating.
Weight	2 - 3 oz.
Types of Use	Indoor wrapped upholstery, surface inlay, and headboards. Residential and commercial interiors.
Pricing	Sold by the square foot.
Available Sizes	Custom sizes available. Please check with your upholsterer.
Sample Size*	5" x 7" (13 x 18 cm) *Purchase on product pages: www.avoavo.com .
Minimum Order	Whole hide: 45 - 55 sq ft (4.2 - 5.1 sq m) average.
Ordering	Contact us directly to purchase. All inquiries can be made to inquire@avoavo.com . Orders require a 50% deposit.
Trade Account	We offer a trade discount to interior designers and architects. Please contact us for a quote.
Lead Time	Made to order 6 - 8 weeks lead time.
Care	Dust with a dry cloth, sweep, or gently vacuum with a hose attachment (never use "carpet mode" or attachments with a spinning brush). If a spill or spot should occur, blot immediately with a clean absorbent cloth or sponge - no wiping or scrubbing. Then let air dry completely. Do not use solvents or harsh cleaners. Recondition as needed. Always perform a test before proceeding.
Customization	Size, scale and color can be customized. See our color library for reference: www.avoavo.com/color .
Variations	Leather is a natural product that we dye by hand. Each hide is unique and lots made at different times may vary slightly in color. Avoid exposure to direct sunlight as it might change or fade the color of your leather.
Manufacture	Hand dyed in Brooklyn. Made in the United States.

Upholstery

Leather Upholstery Guide

Here is a general reference guide to upholstery . Please check with your upholsterer



1.5 yds. / 27 sq. ft.

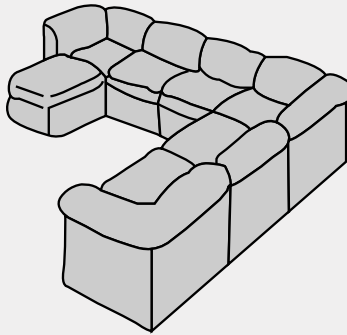

30.5 yds. / 711 sq. ft.

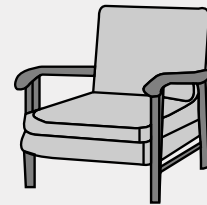

3.5 yds. / 83 sq. ft.

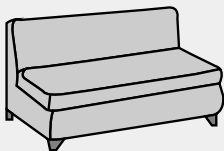

9 yds. / 152 sq. ft.

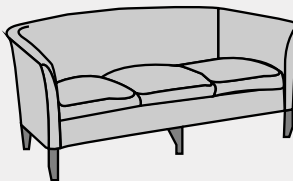

12 yds. / 216 sq. ft.

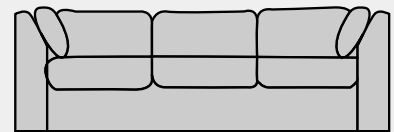

22 yds. / 396 sq. ft.



1 yd. / 18 sq. ft.

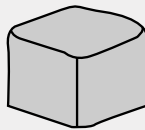

1.5 yds. / 27 sq. ft.

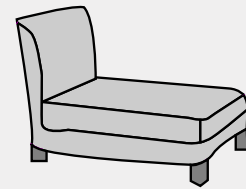

5.5 yd. / 90 sq. ft.

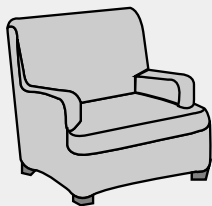

5.5 yds. / 90 sq. ft.

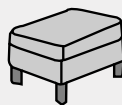

2.5 yds. / 45 sq. ft.

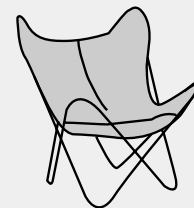

5.5 yd. / 90 sq. ft.

Upholstery

Weathered Cane



Weathered Cane | Marigold

Weathered Cane layers together translucent lines into a structured nest. This design is a perfectly imperfect geometric rug, inspired by traditional canned chairs.

Hand dyed graphics create a modern juxtaposition between material and pattern. Upholstery is a way to transform your space through objects. Reinvent your favorite chair or create statement pieces for each room from scratch. All of our leather upholstery is hand dyed to order by our team of artisans and suitable for residential and commercial spaces.



Weathered Cane | Sage



Weathered Cane | Terracotta

Upholstery

Weathered Cane



Pattern	Weathered Cane.
Material	Hand dyed cowhide leather.
Leather Type	Natural milled texture and full grain cowhide.
Repeat	Pattern seamlessly over full cowhide.
Finish	Satin-sheen, water and stain resistant protective coating.
Weight	3 - 4 oz.
Types of Use	Indoor wrapped upholstery, surface inlay, and headboards. Residential and commercial interiors.
Pricing	Sold by the square foot.
Available Sizes	Custom sizes available. Please check with your upholsterer.
Sample Size*	5" x 7" (13 x 18 cm) *Purchase on product pages: www.avoavo.com .
Minimum Order	Whole hide: 45 - 55 sq ft (4.2 - 5.1 sq m) average.
Ordering	Contact us directly to purchase. All inquiries can be made to inquire@avoavo.com . Orders require a 50% deposit.
Trade Account	We offer a trade discount to interior designers and architects. Please contact us for a quote.
Lead Time	Made to order 6 - 8 weeks lead time.
Care	Dust with a dry cloth, sweep, or gently vacuum with a hose attachment (never use "carpet mode" or attachments with a spinning brush). If a spill or spot should occur, blot immediately with a clean absorbent cloth or sponge - no wiping or scrubbing. Then let air dry completely. Do not use solvents or harsh cleaners. Recondition as needed. Always perform a test before proceeding.
Customization	Size, scale and color can be customized. See our color library for reference: www.avoavo.com/color .
Variations	Leather is a natural product that we dye by hand. Each hide is unique and lots made at different times may vary slightly in color. Avoid exposure to direct sunlight as it might change or fade the color of your leather.
Manufacture	Hand dyed in Brooklyn. Made in the United States.

Upholstery

Leather Upholstery Guide

Here is a general reference guide to upholstery . Please check with your upholsterer



1.5 yds. / 27 sq. ft.

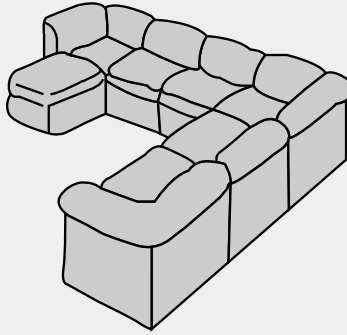

30.5 yds. / 711 sq. ft.

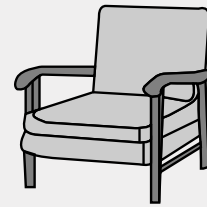

3.5 yds. / 83 sq. ft.

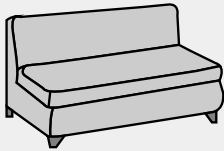

9 yds. / 152 sq. ft.

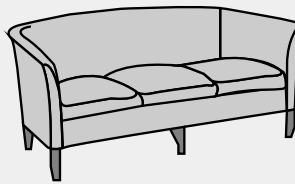

12 yds. / 216 sq. ft.

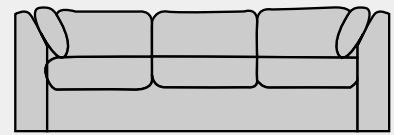

22 yds. / 396 sq. ft.



1 yd. / 18 sq. ft.

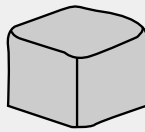

1.5 yds. / 27 sq. ft.

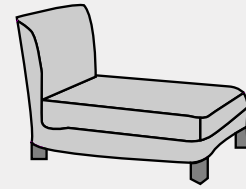

5.5 yd. / 90 sq. ft.

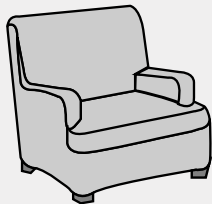

5.5 yds. / 90 sq. ft.

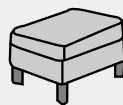

2.5 yds. / 45 sq. ft.

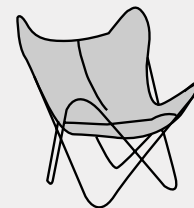

5.5 yd. / 90 sq. ft.